



Izdvajamo iz ponude

PROMOCIJA

LISTOPAD 2024.



Cijene u letku su veleprodajne izražene u eurima bez PDV-a. Fotografije i proizvodi ne moraju u potpunosti odgovarati stvarnom izgledu proizvoda.

Ne preuzimamo odgovornost za moguće greške u produkciji.

Cijene za prikazane artikle vrijede od 01.10.2024. do 31.10.2024. ili do isteka zaliha.

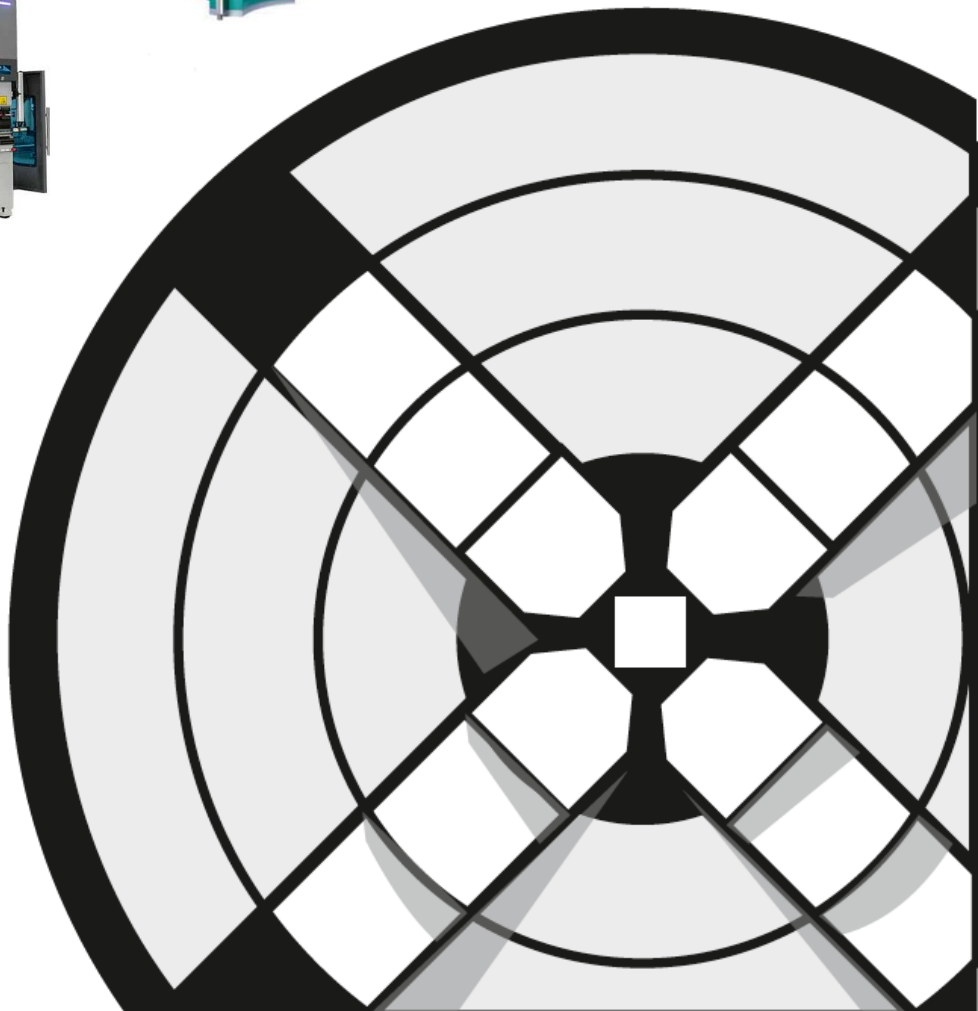



Usluge viličara i dizalice

⇒ Nudimo usluge preseljenja strojeva i opreme



Vozni park:

- ✓ viličari od 1,5 t do 16t
- ✓ kamioni s dizalicama – podizanje do 16t
- ✓ labudica



Pločice za tokarenje

VPC: 2,50 € / kom

**DOSTUPNO
ODMAH**

	Naziv	Kataloški broj
	CNMG 120408-UG-YG801	22000001-PROMO
	CNMG 120404-UF-YG801	22000003-PROMO
	CCMT 09T304-UG-YG801	22000007-PROMO
	CCMT 09T308-UG-YG801	22000008-PROMO
	CCMT 060208-UG-YG801	22000009-PROMO
	DCMT 070204-UG-YG801	22000013-PROMO
	DCMT 070204-UF-YG801	22000347-PROMO
	DCMT 11T304-UF-YG801	22000348-PROMO
	DCMT 11T308-UG-YG801	22000015-PROMO
	DNMG 150404-UF-YG801	22000016-PROMO
	DNMG 150408-UG-YG801	22000017-PROMO
	DNMG 150604-UF-YG801	22000018-PROMO
	DNMG 150608-UG-YG801	22000019-PROMO
	SNMG 120404-UF-YG801	22000029-PROMO
	SNMG 120408-UG-YG801	22000030-PROMO
	TNMG 160408-UG-YG801	22000037-PROMO
	TNMG 160404-UF-YG801	22000039-PROMO
	VNMG 160404-UF-YG801	22000049-PROMO

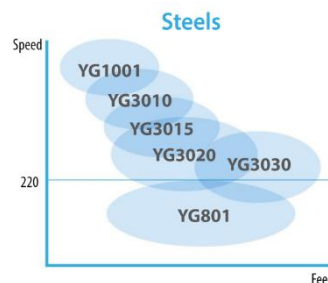

YG801

P10 - P30



for Carbon Steel with Low Cutting Speed

- Recommended for mild steel and boring application
- Substrate and special PVD coating for excellent wear resistance

CNC apkant preša SMART B40220, 4-osi, DELEM DA53T 220 T, 4000 mm, 4 osi + automatska bombaža stola



Oprema stroja

- upravljačka jedinica: **DELEM DA53T**
- osi stroja: Y1 + Y2
- osi graničnika: X-800 mm + R-200 mm
- ACCURL Hybrid funkcija (reduciranje energije za 45%)
- CNC bombiranje stola
- laserska zaštita
- gornji alat postavljen na stroj (segment)
- donji alat postavljen na stroj (segment)
- prednje ruke za pridržavanje materijala na linearnim vodilicama 2 kom
- stražnji graničnici postavljeni na linearne vodilice 2 kom
- CE
- upute za korištenje na engleskom jeziku

Model	B40220
Sila savijanja	220 T
Dužina savijanja	4000 mm
Točnost pozicioniranja	0,005 mm
Razmak među stupovima	3300 mm
Hod grede	200 mm
Svijetli otvor	460 mm
Dubina grla	400 mm
Širina stola	100 mm
Visina radnog stola	1000 mm
Hod graničnika X-osi	800 mm
Hod graničnika R-osi	200 mm
Snaga hibridnog servo motora	18,5 kW
Radna temperatura prostora	0 °C do 40 °C
Dimenzije stroja (dxšxv)	4850x1900x2950 mm
Masa stroja	14500 kg
Napajanje	480 V 3 ph, 50/60 Hz
Brzine	s Hybrid sustavom
Brzina približavanja	200 mm/sec
Brzina savijanja	0-15 mm/sec
Brzina povrata	180 mm/sec
Cijena VPC	64.900,00 €



CNC apkant preša EURO PRO B32135



DOSTUPNO
ODMAH

Model	EURO PRO B32135
Sila savijanja	135 T
Dužina savijanja	3200 mm
Pozicioniranje točnost	0.005 mm
Razmak među stupovima	2700 mm
Ponovljivost kuta savijanja	±2' na metar
Hod grede	200 mm
Svijetli otvor	430 mm
Dubina grla	400 mm
Širina stola	90 mm
Visina radnog stola	940 mm
Tlak u hidraulici	275 bar
Snaga hibridnog servo motora	11 kW
Radna temperatura prostora	0 °C do 40 °C
Dimenzije stroja	4250x1950x2750 mm
Masa stroja	8850 kg
Napajanje	480 V 3 ph, 50/60 Hz
Brzine s Hybrid servo sustavom:	
Brzina približavanja	200 mm/sec
Brzina savijanja	0-15 mm/sec
Brzina povrata	180 mm/sec
Cijena VPC	57.900,00 €

Oprema stroja

- Upravljačka jedinica: **DELEM DA66T**
- Software: Delem CAD/CAM Profile T2D offline (DXF)
- Osi stroja: Y1 + Y2
- Osi graničnika: X + R
- ACCURL Hybrid funkcija (reduciranje energije za 45%)
- CNC bombiranje stola
- Laserska zaštita
- Gornji alat postavljen na stroj (segment)
- Donji alat postavljen na stroj (segment)
- Prednje ruke za pridržavanje materijala na linearnim vodilicama 2 kom
- Stražnji graničnici postavljeni na linearne vodilice 2 kom
- CE
- Upute za korištenje na engleskom jeziku



Mikrometri za unutarnje mjerenje u dvije i tri točke

DIN 863-4

2-12 mm - podjela 0.001 mm / 12-300 mm - podjela 0.005 mm

←INSIZE→

15%

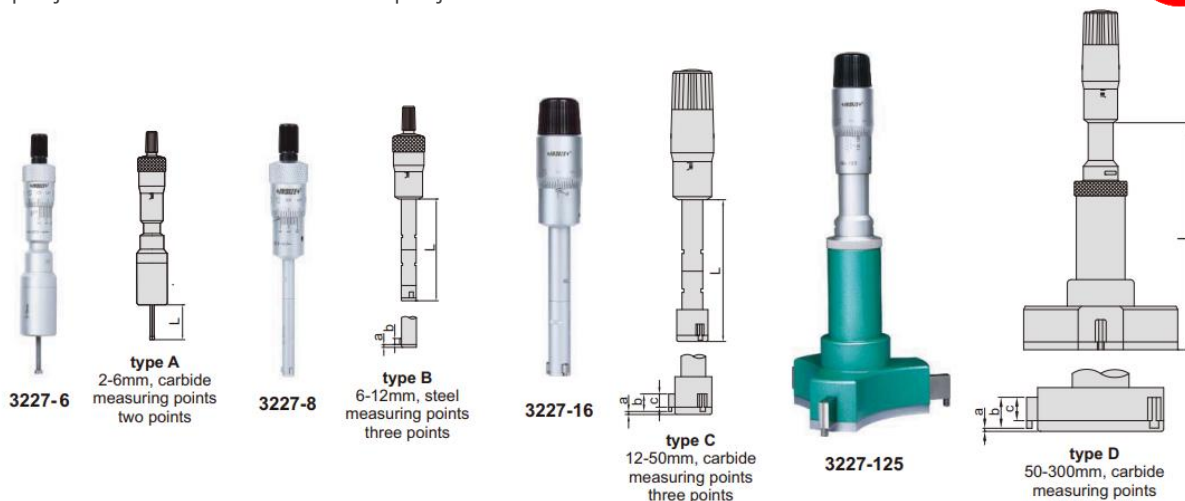

Kataloški broj	Raspon	Tip	Točnost	Prsten za umjeravanje (uključen)	Produžetak (uključen)	L	a	b	C	Redovna cijena	Akcijska cijena
3227-2*	2-2.5mm	A (dvije točke)	6μm	Ø 2.5 DA	---	12	---	---	---	401,00 €	340,85 €
3227-3 *	2.5-3mm	A (dvije točke)	6μm	Ø 2.5 DA	---	12	---	---	---	484,00 €	411,40 €
3227-4*	3-4mm	A (dvije točke)	6μm	Ø 4 DA	---	22	---	---	---	404,00 €	343,40 €
3227-5*	4-5mm	A (dvije točke)	6μm	Ø 5 DA	---	22	---	---	---	394,00 €	334,90 €
3227-6 *	5-6mm	A (dvije točke)	6μm	Ø 6 DA	---	22	---	---	---	394,00 €	334,90 €
3227-8 *	6-8mm	B (tri točke)	4μm	Ø 6 DA	100	54.5	1.5	2.5	---	236,00 €	200,60 €
3227-10*	8-10mm	B (tri točke)	4μm	Ø 8 DA	100	54.5	1.5	2.5	---	236,00 €	200,60 €
3227-12*	10-12mm	B (tri točke)	4μm	Ø 10 DA	100	54.5	1.5	2.5	---	236,00 €	200,60 €
3227-16*	12-16mm	C (tri točke)	4μm	Ø 16 DA	150	80	0.5	6	4.5	188,00 €	159,80 €
3227-20*	16-20mm	C (tri točke)	4μm	Ø 16 DA	150	80	0.5	6	4.5	188,00 €	159,80 €
3227-25*	20-25mm	C (tri točke)	4μm	Ø 25 DA	150	90	0.5	8	6	247,00 €	209,95 €
3227-30*	25-30mm	C (tri točke)	4μm	Ø 25 DA	150	90	0.5	8	6	247,00 €	209,95 €
3227-40*	30-40mm	C (tri točke)	4μm	Ø 40 DA	150	97	0.5	14	12	281,00 €	238,85 €
3227-50*	40-50mm	C (tri točke)	5μm	Ø 40 DA	150	97	0.5	14	12	306,00 €	260,10 €
3227-63*	50-63mm	D (tri točke)	5μm	Ø 62 DA	150	114	0.5	17.5	14.5	339,00 €	288,15 €
3227-75*	62-75mm	D (tri točke)	5μm	Ø 62 DA	150	114	0.5	17.5	14.5	351,00 €	298,35 €
3227-88*	75-88mm	D (tri točke)	5μm	Ø 87 DA	150	114	0.5	17.5	14.5	369,00 €	313,65 €
3227-100*	87-100mm	D (tri točke)	5μm	Ø 87 DA	150	114	0.5	17.5	14.5	387,00 €	328,95 €
3227-125*	100-125mm	D (tri točke)	6μm	opcija	150	140	0.9	29	25	485,00 €	412,25 €
3227-150*	125-150mm	D (tri točke)	6μm	opcija	150	140	0.9	29	25	549,00 €	466,65 €
3227-175*	150-175mm	D (tri točke)	7μm	opcija	150	140	0.9	29	25	608,00 €	516,80 €
3227-200*	175-200mm	D (tri točke)	7μm	opcija	150	140	0.9	29	25	702,00 €	596,70 €
3227-225	200-225mm	D (tri točke)	8μm	opcija	150	140	0.9	29	25	895,00 €	760,75 €
3227-250	225-250mm	D (tri točke)	8μm	opcija	150	140	0.9	29	25	1.012,00 €	860,20 €
3227-275	250-275mm	D (tri točke)	9μm	opcija	150	140	0.9	29	25	1.173,00 €	997,05 €
3227-300	275-300mm	D (tri točke)	9μm	opcija	150	140	0.9	29	25	1.363,00 €	1.158,55 €

*Isporučuje se s certifikatom proizvođača

Metal-Kovis d.o.o., Mala Rakovica, Stara cesta 14, Samobor
 info@metal-kovis.hr
 + 385 1 3364 944

Metal-Kovis AS d.o.o., Jug I 23A, Prelog
 prelog@metal-kovis.hr
 + 385 40 645 518

Setovi mikrometra za unutarnje mjerjenje u tri točke



Kataloški broj	Raspon	Uključeni mikrometri	Prsten za umjeravanje (uključen)	Produžetak (uključen)	Redovna cijena	Akcijska cijena
3227-232*	2-3mm	2-2.5mm, 2.5-3mm	Ø2.5mm	---	799,00 €	679,15 €
3227-363*	3-6mm	3-4mm, 4-5mm, 5-6mm	Ø4mm, Ø5mm, Ø6mm	---	1.152,00 €	979,20 €
3227-123 *	6-12mm	6-8mm, 8-10mm, 10-12mm	Ø6mm, Ø8mm, Ø10mm	100mm	559,00 €	475,15 €
3227-202*	12-20mm	12-16mm, 16-20mm	Ø16mm	150mm	327,00 €	277,95 €
3227-504*	20-50mm	20-25mm, 25-30mm, 30-40mm, 40-50mm	Ø25mm, Ø40mm	150mm	773,00 €	657,05 €
3227-1004*	50-100mm	50-63mm, 62-75mm, 75-88mm, 87-100mm	Ø62mm, Ø87mm	150mm	1.104,00 €	938,40 €

*Isporučuje se s certifikatom proizvođača

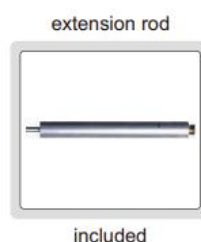

Mikrometri za unutarnje mjerjenje u dvije točke



Unit: mm

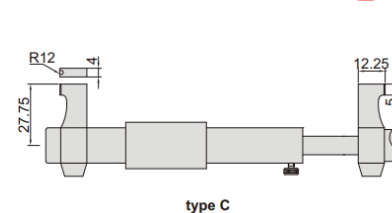
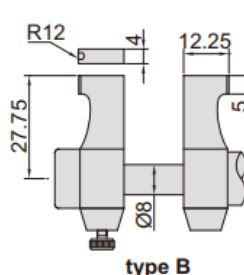
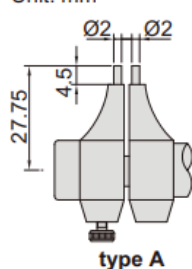

Kataloški broj	Raspon	Tip	Kontrolni prsten	Točnost	Redovna cijena	Akcijska cijena
3220-30	5-30 mm	A	5 mm (uključeno)	±7µm	61,80 €	52,53 €
3220-50	25-50 mm	B	25 mm (uključeno)	±8µm	66,70 €	56,69 €
3220-75	50-75 mm	B	50 mm (opcija)	±9µm	78,30 €	66,55 €
3220-100	75-100 mm	C	75 mm (opcija)	±10µm	87,90 €	74,71 €

- podjela 0.01 mm
- dodirne površine od karbida

Vanjski mikrometri

15%

INSIZE



3203-25A



3203-50A



3203-1004A



3203-3006A

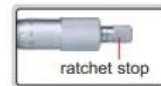

- podjela: 0.01 mm
- dodirne površine od karbida
- DIN863-1
- kontrolni pin uključen osim za 0-25 mm
-

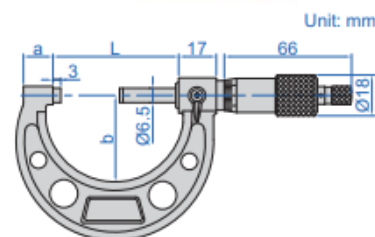

Katloški broj	Raspon	Točnost	L	a	b	Redovna cijena	Akcijska cijena
3203-25A*	0-25mm	±2μm	32mm	9mm	28mm	16,70 €	14,19 €
3203-50A*	25-50mm	±2μm	57mm	14mm	38mm	21,40 €	18,19 €
3203-75A*	50-75mm	±2μm	82mm	15mm	49mm	27,90 €	23,71 €
3203-100A*	75-100mm	±3μm	107mm	15mm	60mm	31,30 €	26,60 €
3203-125A	100-125mm	±3μm	133mm	16.5mm	73mm	42,50 €	36,12 €
3203-150A	125-150mm	±3μm	158mm	16.5mm	85mm	48,70 €	41,39 €
3203-175A	150-175mm	±4μm	183mm	19.4mm	104mm	61,70 €	52,44 €
3203-200A	175-200 mm	±4μm	209mm	19.4 mm	117mm	64,30 €	54,65 €
3203-225A	200-225mm	±4μm	234mm	19.4mm	130mm	69,30 €	58,90 €
3203-250A	225-250mm	±5μm	260mm	19.4mm	142mm	80,00 €	68,00 €
3203-275A	250-275mm	±5μm	285mm	19.4mm	155mm	89,00 €	75,65 €
3203-300A	275-300mm	±5μm	310mm	19.4mm	168mm	94,60 €	80,41 €

Katloški broj	Raspon	Uključeni mikrometri	Redovna cijena	Akcijska cijena
3203-753A*	0-75mm	3203-25A, 3203-50A, 3203-75A	78,80 €	66,98 €
3203-1004A*	0-100mm	3203-25A, 3203-50A, 3203-75A, 3203-100A	100,00 €	85,00 €
3203-1506A	0-150mm	3203-25A, 3203-50A, 3203-75A, 3203-100A, 3203-125A, 3203-150A	185,00 €	157,25 €
3203-3006A	150-300mm	3203-175A, 3203-200A, 3203-225A, 3203-250A, 3203-275A, 3203-300A	446,00 €	379,10 €
3203-3012A	0-300mm	3203-25A, 3203-50A, 3203-75A, 3203-100A, 3203-125A, 3203-150A, 3203-175A, 3203-200A, 3203-225A, 3203-250A, 3203-275A, 3203-300A	650,00 €	552,50 €

*Isporučuje se s certifikatom proizvođača